

OWNER'S GUIDE

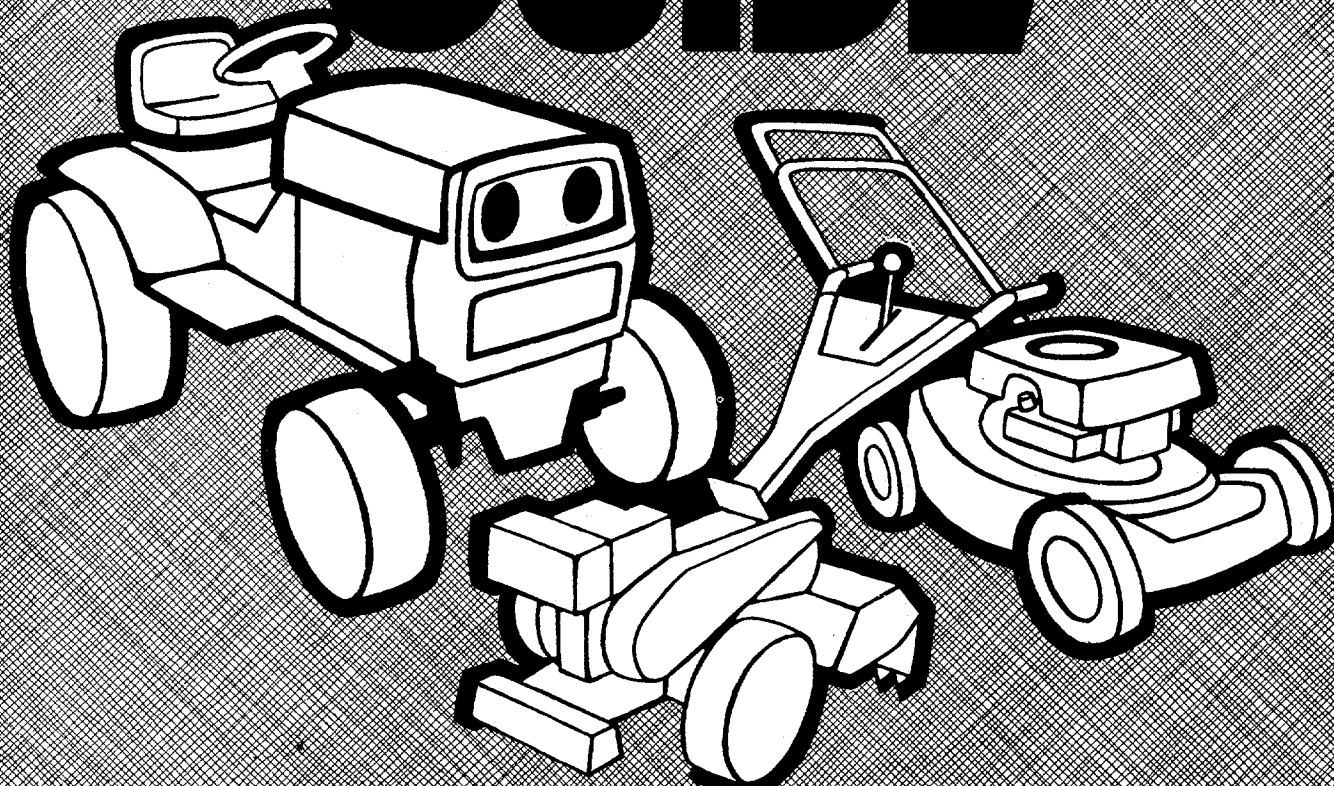

ASSEMBLY • OPERATION • MAINTENANCE • PARTS

22" REAR DISCHARGE PROFESSIONAL ROTARY MOWER

Important:

**Read Safety Rules and
Instructions Carefully**

**Model Number
111-638A**

Thank you for purchasing an
American built product.

INDEX

Safe Operation Practices.....	3	Maintenance	13
Assembly	4	Off-Season Storage.....	15
Operation	11	Exploded Parts View.....	18
Adjustments.....	12	Repair Parts List.....	19
Lubrication.....	13	Parts Information.....	Back Cover

MTD PROFESSIONAL LIMITED WARRANTY

For one year from the date of original retail purchase, MTD PRODUCTS INC will either repair or replace, at its option, free of charge, F.O.B. factory or authorized service firm, any part or parts found to be defective in material or workmanship. Transportation charges for any parts submitted for replacement under this warranty must be paid by the purchaser unless such return is requested by MTD PRODUCTS INC.

This warranty will not apply to any part which has become inoperative due to misuse, excessive use, accident, neglect, improper maintenance, alterations, or unless the unit has been operated and maintained in accordance with the instructions furnished. This warranty does not apply to the engine, motor, battery, battery charger or component parts thereof. Please refer to the applicable manufacturer's warranty on these items.

Warranty service is available through your local authorized service dealer or distributor. If you do not know the dealer or distributor in your area, please write to the Customer Service Department of MTD.

The return of a complete unit will not be accepted by the factory unless prior written permission has been extended by MTD.

This warranty gives you specific legal rights. You may also have other rights which vary from state to state.



WARNING

TO PURCHASERS OF INTERNAL COMBUSTION ENGINE EQUIPPED MACHINERY OR DEVICES IN THE STATE OF CALIFORNIA

The equipment which you have just purchased does not have a spark arrester. If this equipment is used on any forest covered land, brush covered land, or grass covered unimproved land in the State of California, before using on such land, the California law requires that a spark arrester be provided. In addition, spark arrester is required by law to be in effective working order. The spark arrester must be attached to the exhaust system and comply with Section 4442 of the California Public Resources Code.



WARNING

To reduce the potential for any injury, comply with the following safety instructions. Failure to comply with the instructions may result in personal injury.

SAFE OPERATION PRACTICES FOR WALK-BEHIND MOWERS

TRAINING

1. It is suggested that this manual be read in its entirety before attempting to assemble or operate this unit. Keep this manual in a safe place for future reference and for ordering replacement parts.
2. Your rotary mower is a precision piece of power equipment, not a plaything. Therefore, exercise extreme caution at all times.
3. Read this Owner's Manual carefully. Be thoroughly familiar with the controls and the proper use of the equipment.
4. Never allow children to operate a power mower. Only persons well acquainted with these rules of safe operation should be allowed to use your mower.
5. Keep the area of operation clear of all persons, particularly small children and pets. Stop engine when they are in the vicinity of your mower. Although the area of operation should be completely cleared of foreign objects, a small object may have been overlooked and could be accidentally thrown by the mower in any direction and cause injury.

PREPARATION

1. Thoroughly inspect the area where the equipment is to be used. Remove all stones, sticks, wire, bones and other foreign objects which could be picked up and thrown by the mower in any direction and cause injury.
2. Do not operate equipment when barefoot or wearing open sandals. Always wear substantial footwear.
3. Do not wear loose fitting clothing that could get caught on the mower.
4. Check the fuel before starting the engine. Gasoline is an extremely flammable fuel. Do not fill the gasoline tank indoors, while the engine is running, or while the engine is still hot. Wipe off any spilled gasoline before starting the engine as it may cause a fire or explosion.
5. Disengage the self-propelled mechanism or drive clutch on units so equipped before starting the engine.
6. Never attempt to make a wheel or cutting height adjustment while the engine is running.
7. Mow only in daylight or in good artificial light.
8. Never operate the equipment in wet grass. Always be sure of your footing. Keep a firm hold on the handle and walk, never run.

OPERATION

1. Do not change the engine governor settings or overspeed the engine. Excessive engine speeds are dangerous.
2. Do not put hands or feet near or under rotating parts. Keep clear of the discharge opening at all times as the rotating blade can cause injury.
3. Stop the blade when crossing gravel drives, walks or roads.
4. After striking a foreign object, stop the

engine, remove the wire from the spark plug, and thoroughly inspect the mower for any damage. Repair the damage before restarting and operating the mower.

5. If the equipment should start to vibrate abnormally, stop the engine and check immediately for the cause. Vibration is generally a warning of trouble.
6. Stop the engine whenever you leave the mower, before cleaning the mower housing, and when making any repairs or inspections.
7. When cleaning, repairing or inspecting, make certain the blade and all moving parts have stopped. Disconnect the spark plug wire, and keep the wire away from the plug to prevent accidental starting.
8. Before attempting to unclog the mower or discharge chute, stop the engine and be sure the blade has stopped completely. The cutting blade continues to rotate for a few seconds after the engine is shut off. Never place any part of the body in the blade area until you are sure the blade has stopped rotating. Disconnect the spark plug wire and keep the wire away from the plug to prevent accidental starting.
9. Do not run the engine indoors.
10. Shut the engine off and wait until the blade comes to a complete stop before removing the grass catcher or unclogging chute.
11. Mow across the face or slopes, never up-and-down. Exercise extreme caution when changing direction on slopes. Do not mow excessively steep slopes.
12. Always disconnect electric mowers (line operated) before cleaning, repairing or adjusting.
13. Never operate mower without proper guards, plates or other safety protective devices in place.
14. Keep washout ports and other mower-housing service openings closed when mowing.
15. **DO NOT OPERATE** this mower with the chute doors open, unless the complete grass catcher is properly mounted on the mower.

MAINTENANCE AND STORAGE

1. Check the blade and engine mounting bolts at frequent intervals for proper tightness.
2. Keep all nuts, bolts, and screws tight to be sure the equipment is in safe working condition.
3. Never store the equipment with gasoline in the tank inside of a building where fumes may reach an open flame or spark. Allow the engine to cool before storing in any enclosure.
4. To reduce fire hazard, keep the engine free of grass, leaves, or excessive grease.
5. Check the grass catcher bag frequently for wear or deterioration. For safety protection, replace only with new bag meeting original equipment specifications.

ASSEMBLY INSTRUCTIONS

NOTE

This unit is shipped WITHOUT GASOLINE or OIL. After assembly, see operating section of this manual for proper fuel and engine oil recommendations.

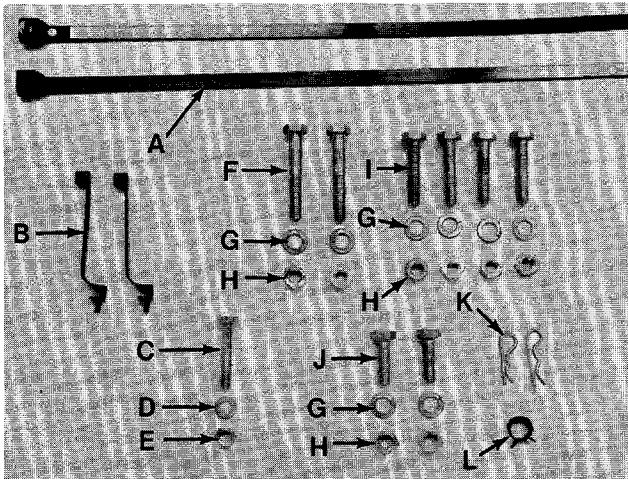

FIGURE 1.

← Contents of Hardware Pack: (See figure 1)

- A (2) Cable Ties (Gas Tank)
- B (2) Cable Ties (Throttle Control Wire)
- C (1) Hex Bolt 1/4-20 x 1.50" Long
- D (1) Lock Washer 1/4" I.D.
- E (1) Hex Nut 1/4-20 Thread
- F (2) Hex Bolts 5/16-18 x 1.75" Long
- G (8) Lock Washers 5/16" I.D.
- H (8) Hex Lock Nuts 5/16-18 Thread
- I (4) Hex Bolts 5/16-18 x 1.50" Long
- J (2) Hex Bolts 5/16-18 x .75" Long
- K (2) Hairpin Cotter
- L (1) Hose Clamp (For Gas Line)

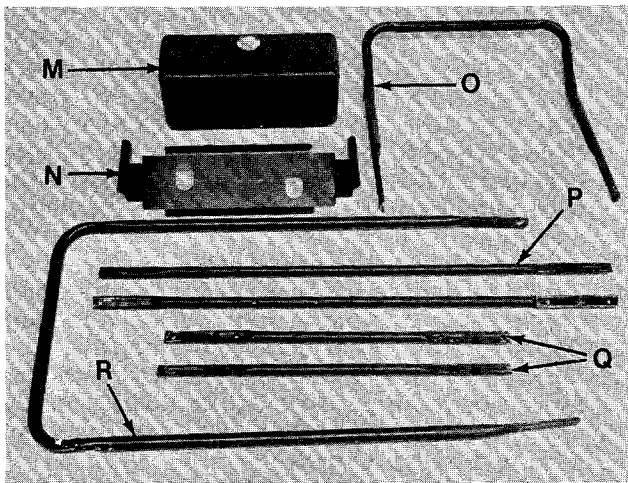

FIGURE 2.

← Loose Contents in Carton: (See figure 2)

- M (1) Gas Tank
- N (1) Gas Tank Bracket
- O (1) Upper Handle
- P (2) Upper Struts
- Q (2) Lower Struts
- R (1) Lower Handle

1. Remove the lawn mower, loose parts, hardware pack and literature from the carton. Make certain all parts and literature have been removed before the carton is discarded.

2. Extend the throttle control which is attached to the mower and place on the floor. Be careful not to bend or kink control wire.

← 3. Place lower handle in position over weld pins in handle mount brackets on deck. Secure by placing two hairpin cotters (K) in inner hole on weld pins. See figure 3.

NOTE

It may be necessary to bend the ends of the lower handle inward slightly to assure a snug fit against the bracket mounting area.

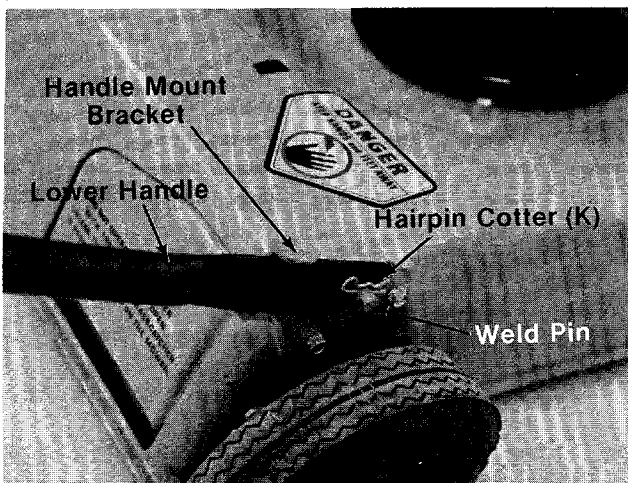
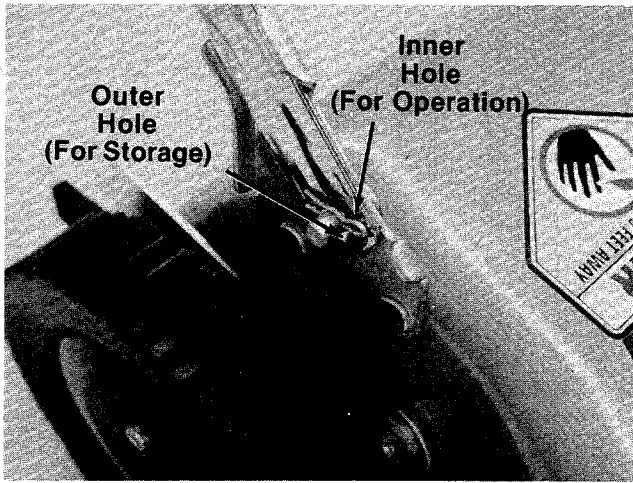

FIGURE 3.



NOTE

There are two (2) holes in the handle mount brackets. Place hairpin cotter in the inner hole for operation. The outer hole is for storage. See figure 4.

FIGURE 4.

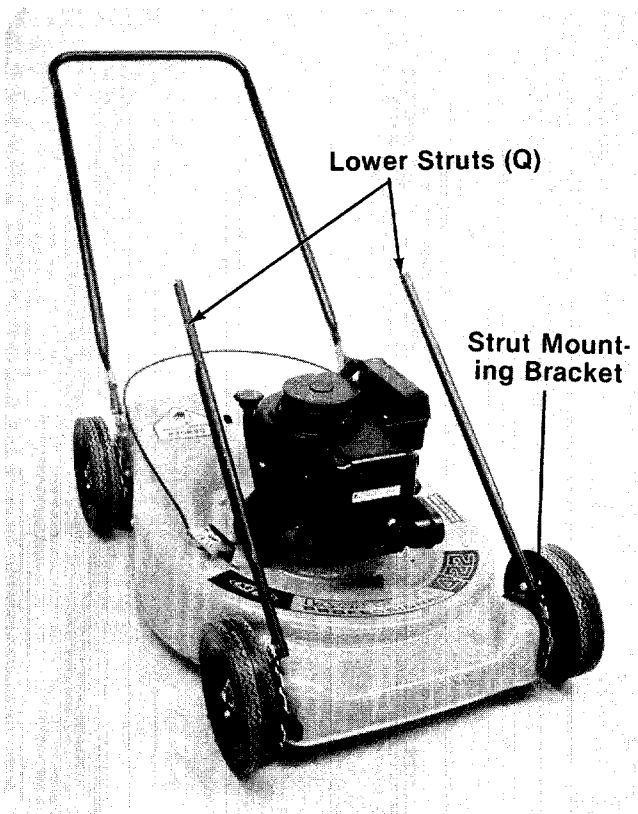

4. Place the lower struts (Q) in position on strut mounting brackets and secure with hex bolts (J), lock washers (G) and lock nuts (H). See figure 5. Do not tighten at this time, only make finger tight.

FIGURE 5.



Gas Tank Mounting Bracket (N)

5. Place the gas tank mounting bracket (N) over the lower struts and start by hand hex bolts (I), lock washers (G) and hex lock nuts (H). See figure 6. Do not tighten at this time.

FIGURE 6.

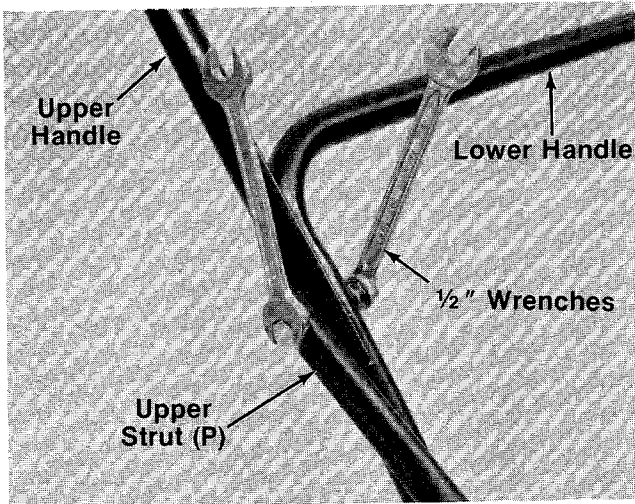

Upper Handle

Lower Handle

1/2" Wrenches

Upper Strut (P)

6. Place upper handle in position over lower handle. Place upper struts (P) over upper handle and secure with hex bolts (F), lock washers (G) and hex lock nuts (H). See figure 7. Tighten securely. Two 1/2" wrenches are required.

FIGURE 7.

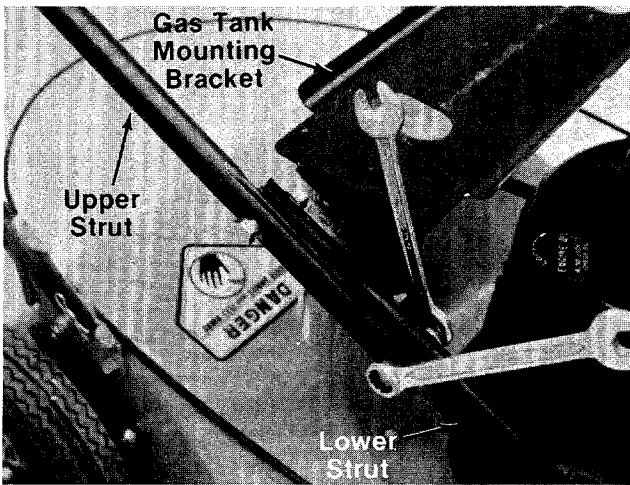

FIGURE 8.

7. Go back and secure the gas tank mounting bracket, upper and lower struts. Tighten securely with $\frac{1}{2}$ " wrenches. See figure 8.

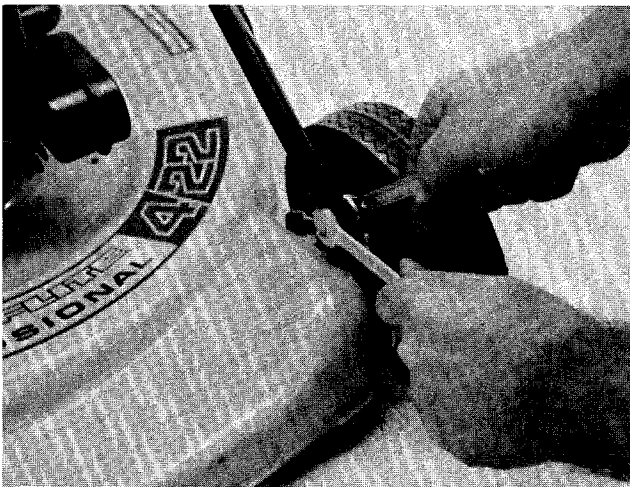

FIGURE 9.

8. Secure the lower struts to strut mounting brackets with two $\frac{1}{2}$ " wrenches. See figure 9.

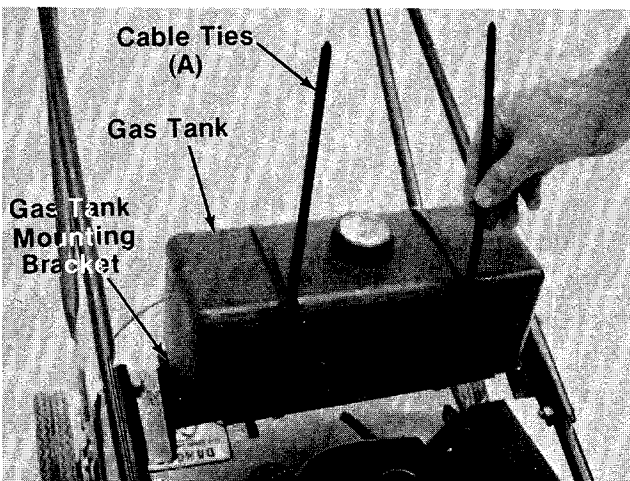

FIGURE 10.

9. Place the gas tank in position on the gas tank mounting bracket. Secure in place with two plastic cable ties (A). See figure 10. Cut off excess ends.

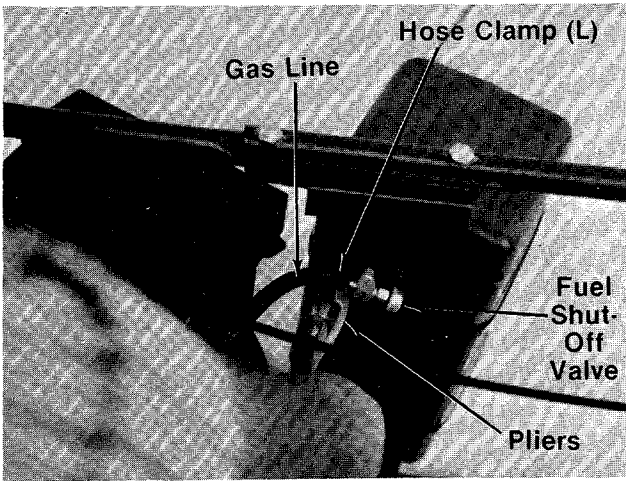

FIGURE 11.

10. With a pair of pliers slip the hose clamp (L) over the end of gas line (already on engine).
- ← Place end of gas line over fuel shut-off valve (on bottom of tank) and secure with hose clamp (L). See figure 11.

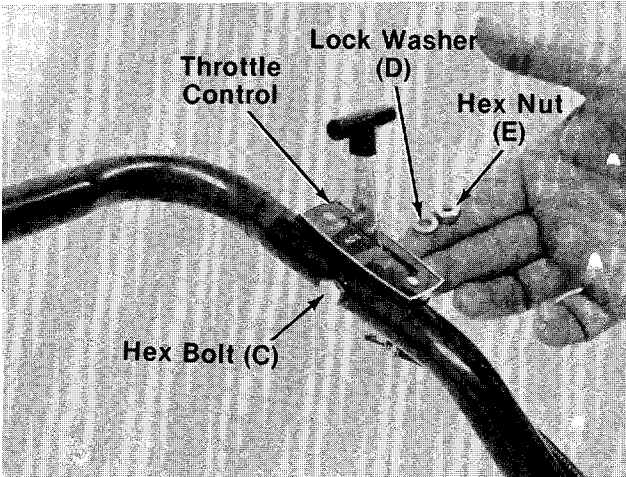

FIGURE 12.

11. Place the throttle control in position on the left hand side of the upper handle. Secure with hex bolt (C), lock washer (D) and hex nut (E) provided. See figure 5.

NOTE

Reference to left or right side of machine is from operator's position at the handle facing forward.

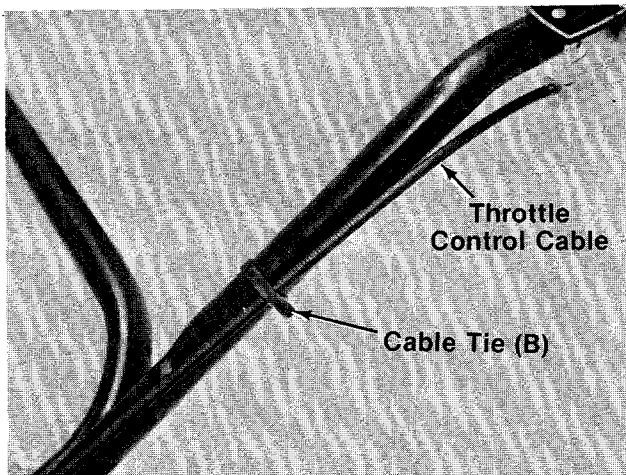

FIGURE 13.

12. Secure throttle control cable to handle with cable ties (B) provided. See figure 13.
13. Check **all** nuts and bolts for correct tightness.

ASSEMBLY Grass Catcher

The grass catcher is partially assembled. See ← figure 14.

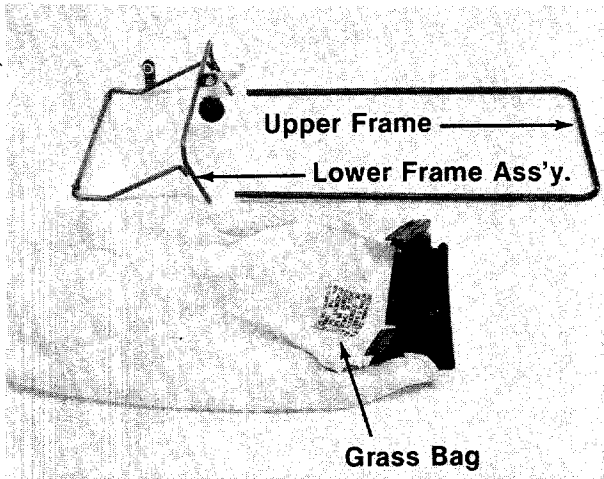
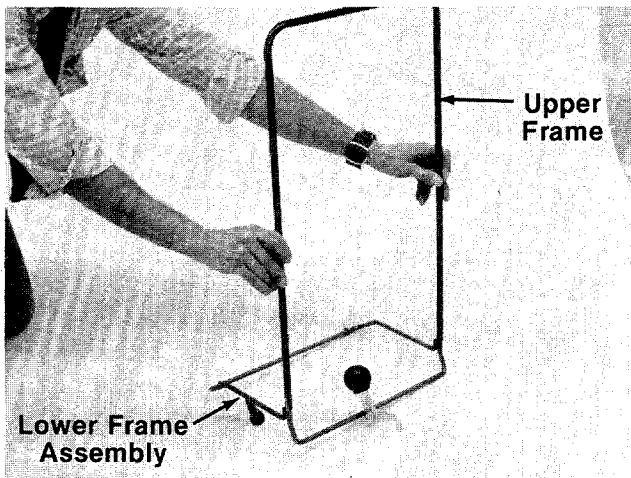
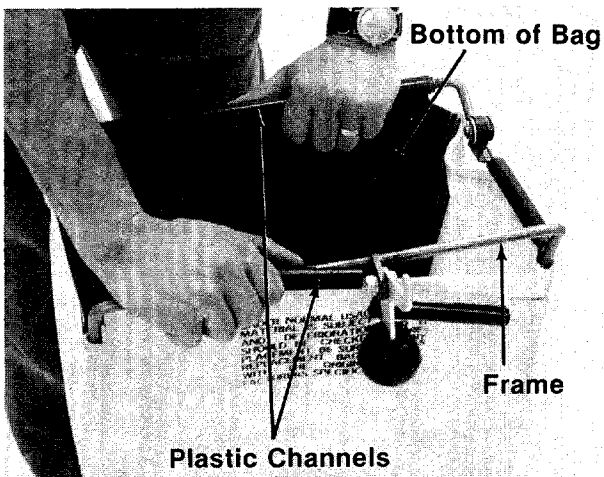

FIGURE 14.



1. Place the upper frame over the lower frame assembly as shown in figure 15. ←

FIGURE 15.



2. Place bag over frame (black plastic side is the bottom of bag). Upper frame goes to the top of bag. ←
3. Secure bag to frame by slipping plastic channels on bag over frame. See figure 16.

FIGURE 16.

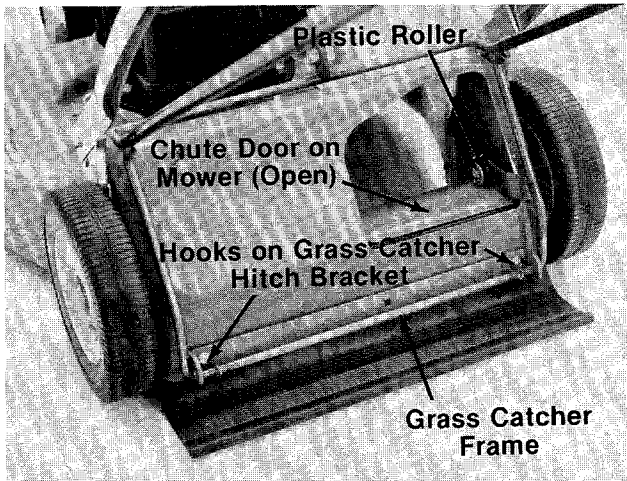

FIGURE 17.

TO ATTACH BAG TO MOWER



WARNING

DO NOT operate the mower with the chute door open unless the complete grass catcher is properly mounted on the mower.

- ← 1. Attach the grass catcher frame to grass catcher hitch bracket on rear of the mower by hooking grass catcher into hooks on grass catcher hitch bracket. See figure 17.
2. Lift the rear of grass catcher up. The roller on the grass catcher will push the chute door on the mower open. See figure 17.



NOTE

Figure 17 is shown with the chute door open for photo clarity only.

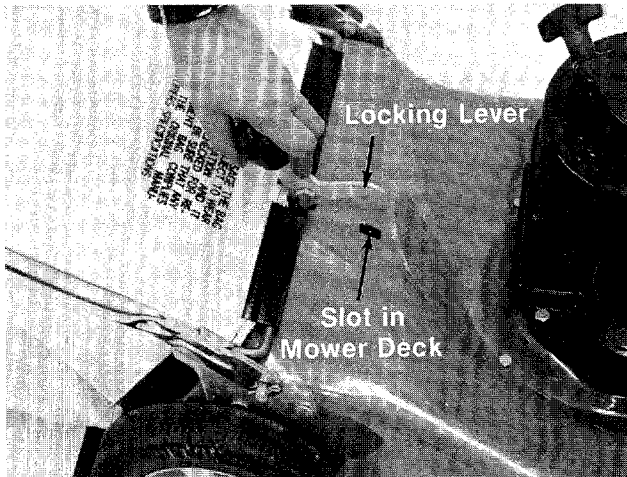

FIGURE 18.

- ← 3. Move the locking lever forward and hook in slot on mower. See figures 18 and 19.

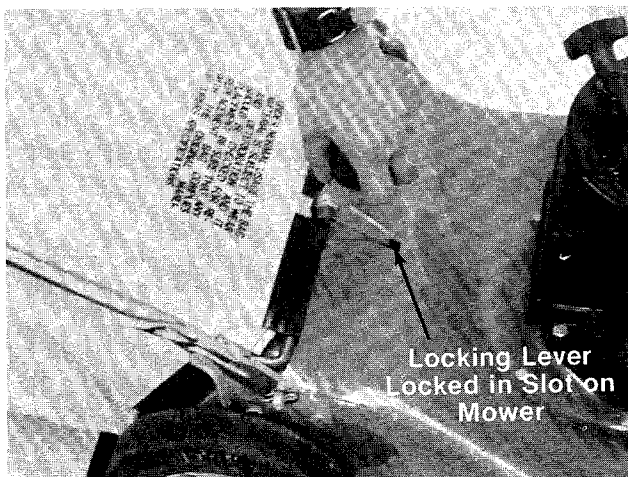

FIGURE 19.

TO REMOVE GRASS CATCHER

1. To remove the grass catcher, lift the rear of grass catcher, push forward and unhook locking lever.
2. Lift off grass catcher. See figure 20.

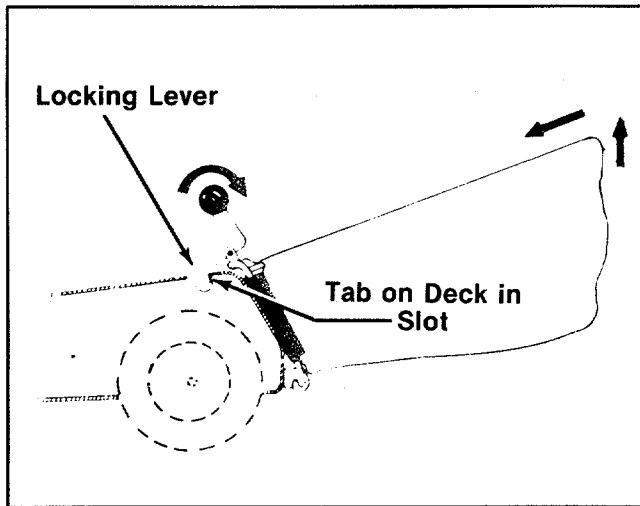

FIGURE 20.

OPERATION

DO NOT OPERATE THIS MOWER WITH THE CHUTE DOOR OPEN, UNLESS THE COMPLETE GRASSCATCHER IS PROPERLY MOUNTED ON THE MOWER.



FIGURE 21.

Keep hands and feet away from the chute area on cutting deck. See figure 21.



For shipping purposes your mower is set with the wheels in a low cutting height position. For best results, raise the cutting position until it is determined which height is best for your lawn. See adjustment section.

BEFORE STARTING

1. Check to see that the handle is in the operating detent in the brackets on the deck, and the upstop projections restrict the handle from moving up and forward. If necessary, remove the left side from the mounting pin on the deck bracket. Push inward to decrease the spacing between the two sides of the handle until it is slightly less than the spacing of the deck brackets. Reinstall over the mounting pin and secure the hairpin cotter in the inner holes.
2. Fill sump with oil, using a high quality detergent oil classified "For Service SC, SD, SE or MS." Use SAE 30, SAE 10W-30 or SAE 10W-40 viscosity grade oil. Nothing should be added to the recommended oil.

Place engine level. Remove the dipstick. See figure 22. Fill to full mark on dipstick. Pour slowly. Capacity 1¼ pints.

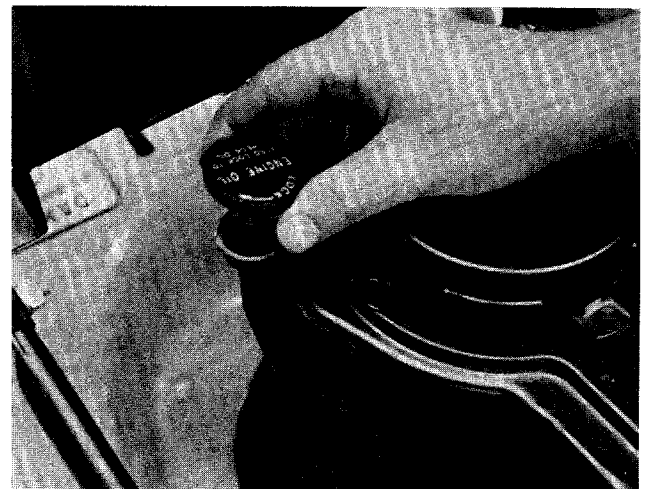

FIGURE 22.

3. Fill fuel tank, using clean, fresh leaded **regular** grade automotive gasoline. Fill tank completely.
DO NOT MIX OIL WITH GASOLINE.

TO START ENGINE

1. Move throttle control lever to "START" position.
2. Place foot on right side of deck and hold handle to prevent tipping the unit. Grasp starter and pull out rapidly. Return it slowly to the engine. Repeat if necessary.



This engine features a unique Automatic Choke. In case of flooding, move control to "STOP" and pull starter six times. Then move control to "START" position and start engine. If engine continues to flood, rotate the carburetor needle valve 1/8 turn clockwise to obtain a leaner mixture. See Carburetor Adjustment in engine manual.

This mower is designed to be operated at full throttle to give you the best cut and do the most effective job of bagging the cut grass.

TO STOP ENGINE

1. Move throttle control lever to "STOP" position.
2. Remove spark plug wire from spark plug and ground to prevent accidental starting while equipment is unattended.

Be sure that lawn is clear of stones, sticks, wire, or other objects which could damage lawn mower or engine. For best results and to insure more even grass distribution, do not mow when lawn is excessively wet.



After striking a foreign object, stop the engine. Remove wire from spark plug, thoroughly inspect the mower for any damage, and repair the damage before restarting and operating the mower.

ADJUSTMENTS



Do not at any time make any adjustment to lawn mower without first stopping engine and disconnecting spark plug wire.

CUTTING HEIGHT

An adjusting plate and thumb lever at each wheel position provides cutting height adjustment. Each adjusting plate has five holes. Height of cut will be changed when the thumb lever is moved from one hole to another. Simply depress the lever towards wheel and move wheel and lever assembly to desired position. See figure 23.

Cutting height will be raised as front and rear levers are lowered. Cutting height will be lowered as front and rear levers are raised. All wheels must be positioned at the same height.

For rough or uneven lawns, move the wheels to a position which will give a higher cutting height.

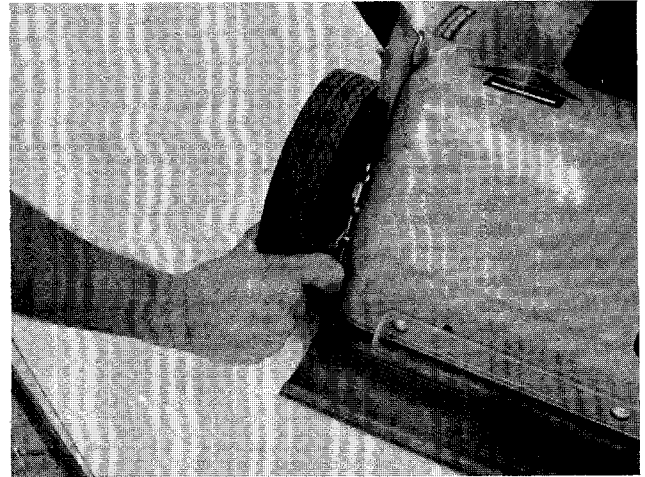

FIGURE 23.

THROTTLE

If adjustment becomes necessary, the throttle control wire assembly can be reset as follows:

1. Loosen, but do not remove, the screw securing throttle control wire assembly at engine. See figure 24.

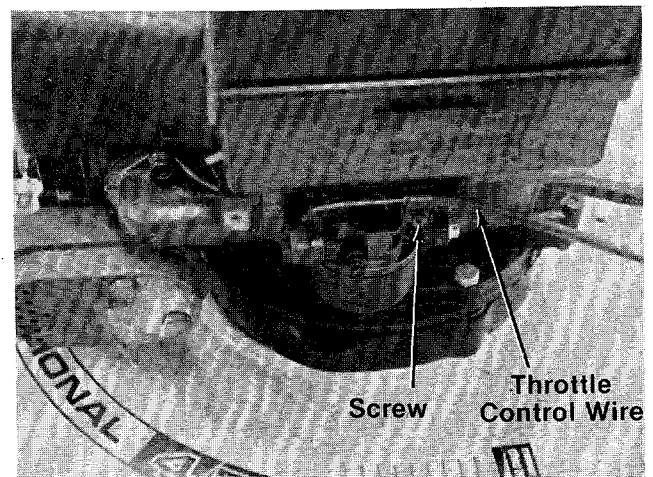

FIGURE 24.

2. Move throttle control lever on handle to "FAST" position.
3. Move lever to which control wire is fastened at engine to full open position. Retighten screw to secure throttle control wire assembly.



If any adjustments are made to the engine while the engine is running (e.g. carburetor), disengage all clutches and blades. Keep clear of all moving parts. Be careful of heated surfaces and muffler.

CARBURETOR ADJUSTMENTS (Refer to engine manual for adjustments.)

LUBRICATION

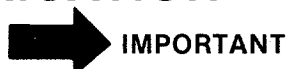

Always stop engine and disconnect spark plug wire before cleaning, lubricating or doing any kind of work on lawn mower.

Wheels—The wheel bearings should be lubricated at least once a season. If the wheels are removed for any reason, lubricate the surface of the axle bolt and the inner surface of the wheel with light oil. A 4 oz. plastic bottle of light oil lubricant is available. Order part number 737-0170. Engine oil may also be used.

Engine—Follow engine manual for lubrication instructions.

Throttle—Periodically lubricate throttle control lever and throttle wire assembly with a few drops of light oil for ease of operation.

Discharge Chute Door Mechanism—The torsion spring and pivot point should be lubricated periodically with light oil to prevent any rust or binding. Doors must work freely.

MAINTENANCE

CUTTING BLADE

A. Removal for Sharpening or Replacement

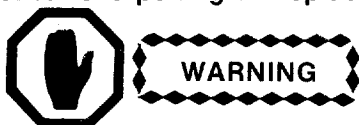

Be sure to disconnect and ground the spark plug wire before working on the cutting blade to prevent accidental engine starting.

1. Remove the large bolt and lock washer which holds the blade and adapter to the engine crankshaft. See figure 25.

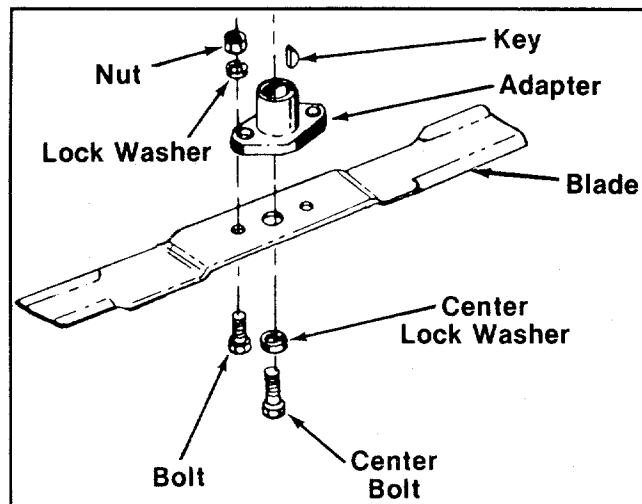

FIGURE 25.

2. Remove the blade and adapter from the crankshaft. Be careful not to lose the key on the crankshaft.
3. If the blade or blade adapter needs replacing, remove the two small bolts, lock washers and nuts which hold the blade to the adapter.

B. Sharpening

Remove the cutting blade by following the directions of the preceding section.

When sharpening the blade, follow the original angle of grind as a guide. It is **extremely important** that each cutting edge receives an equal amount of grinding to prevent an unbalanced blade. An unbalanced blade will cause excessive vibration when rotating at high speeds and may cause damage to the mower.

The blade can be tested for balance by balancing it on a round shaft screwdriver. Remove metal from the heavy side until it balances evenly. See figure 26.



It is recommended that the blade always be removed from the adapter for the best test of balance.

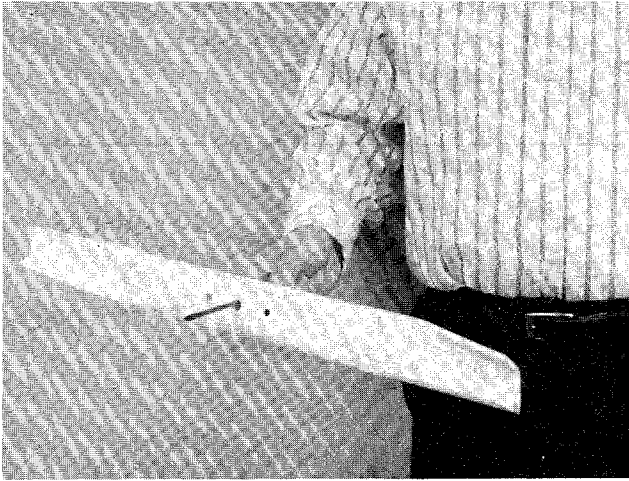

FIGURE 26.

C. Reassembly

Before reassembling the blade and the blade adapter to the unit, lubricate the engine crankshaft and the inner surface of the blade adapter with light oil. Lubricating the bolt holes, bolts and inner surface of the nuts with light oil is also recommended. A 4 oz. plastic bottle of light oil lubricant is available. Order part number 737-0170. Engine oil may also be used.

When replacing the blade, be sure to install the blade with the side of the blade marked "Bottom" (or with part number) facing the ground when the mower is in the operating position. Make certain key is in place on the crankshaft.

Blade Mounting Torque

3/8" Dia. Bolt 375 in. lb. min., 450 in. lb. max.
 5/16" Dia. Bolt 150 in. lb. min., 250 in. lb. max.

To insure safe operation of your unit, ALL nuts and bolts must be checked periodically for correct tightness.

DECK

The underside of the mower deck should be cleaned after each period of use as grass clippings, leaves, dirt and other matter will accumulate. This accumulation of grass clippings, etc., is undesirable as it will invite rust and corrosion and may cause an uneven discharge of grass clippings at the next cutting.

The deck may be cleaned by tilting the mower forward or on its side and scraping clean with a suitable tool or by washing with a stream of water from a garden hose.



CAUTION

Do not direct the stream of water at a hot engine as damage to the engine may result. Be sure spark plug wire is disconnected.

ENGINE OIL

CHECK OIL LEVEL before starting engine and after every 5 hours of operation.

ADD oil as necessary to keep level full to full mark on dipstick.

Engine should be in a level position when checking oil.

CHANGE OIL after first 5 hours of operation. Thereafter change every 25 hours. Change oil while engine is warm. Oil may be drained thru drain on bottom of engine. To drain completely, always place engine level when draining thru the bottom. Oil capacity 1-1/4 pints. See figure 27.

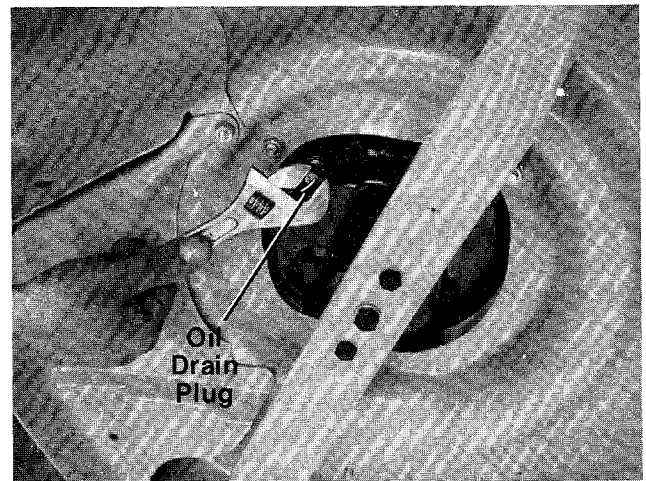

FIGURE 27.

AIR CLEANER

CLEAN AIR CLEANER and re-oil element every 25 hours under normal conditions. Clean every few hours under extremely dusty conditions. Poor engine performance and flooding usually indicates that the air cleaner should be serviced. See figure 28.

1. Snap off the top cover.
 - a. WASH foam element in kerosene or a liquid detergent and water to remove dirt.
 - b. DRY foam completely by wrapping and squeezing in a cloth.
 - c. SOAK foam with engine oil. Squeeze to distribute and remove excess oil.
2. Reassemble foam element and cover.

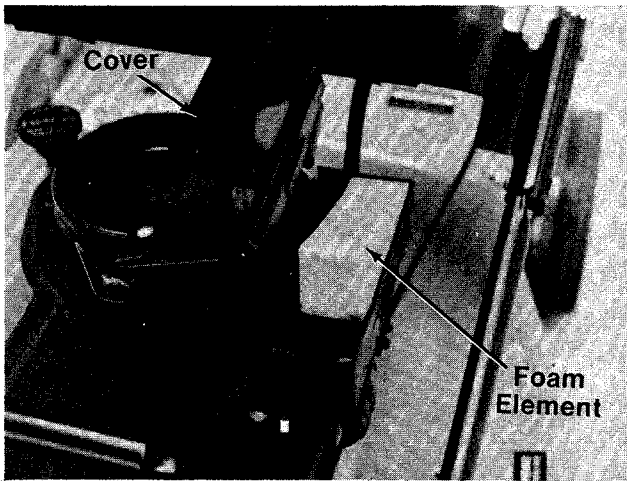

FIGURE 28.
SPARK PLUG

The spark plug should be cleaned (see figure 29) and the gap reset to a 0.030-inch clearance once a season (see figure 30). Spark plug replacement is recommended at the start of each mowing season; check engine manual for correct plug type.

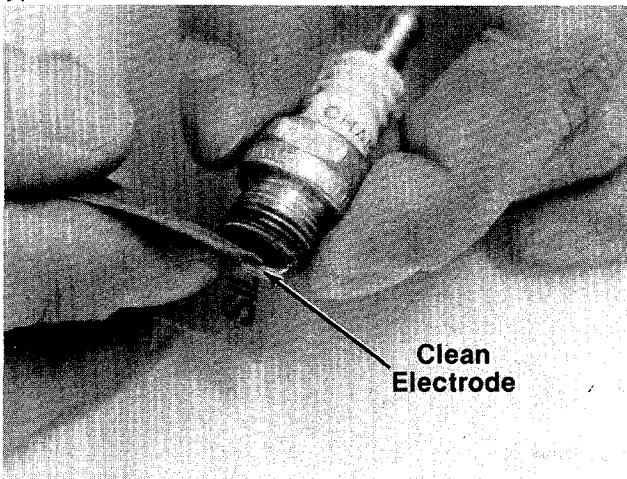

FIGURE 29.

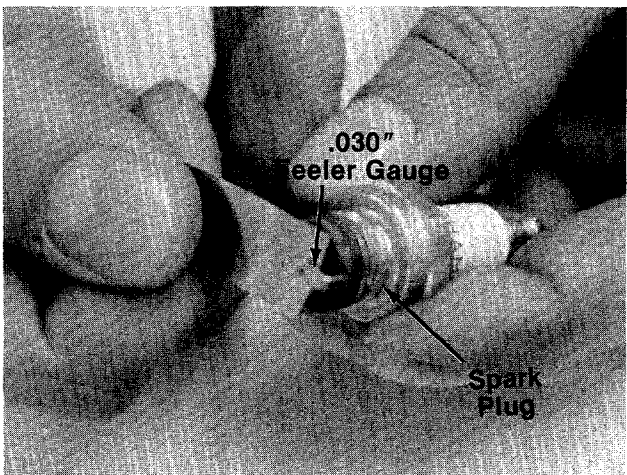

FIGURE 30.

NOTE

Whenever the spark plug is removed for cleaning, it is advisable to replace the spark plug gasket with a new gasket.

OFF-SEASON STORAGE

If the machine is to be inoperative for a period longer than 30 days, the following procedures are recommended:

1. Working outdoors, drain all fuel from the fuel tank. Use a clean dry cloth to absorb the small amount of fuel remaining in the tank. Then run the engine until all fuel in the carburetor is exhausted.



WARNING

Do not drain fuel while smoking, or if near an open fire.

2. Drain all the oil from the crankcase (this should be done after the engine has been operated and is still warm). Refill the crankcase with clean new oil.
3. Disconnect the spark plug wire and remove the spark plug from the cylinder. Pour about 2 or 3 tablespoons of engine oil into the cylinder. Turn the engine over several times to spread out the oil. Replace the spark plug, but do not connect the wire.
4. Clean the engine and the entire mower thoroughly.
5. Lubricate all lubrication points.



NOTE

The use of any accessory on this Rotary Mower other than those manufactured by the mower manufacturer is **not** recommended.



WARNING

DO NOT operate the mower with the chute door open unless the complete grass catcher is properly mounted on the mower.



WARNING

The mower shall not be operated without the protective shield on the rear of the mower in place.



NOTE

Under normal usage bag material is subject to wear and should be checked periodically. Be sure any replacement bag complies with the mower manufacturer's recommendations.

For replacement bags, use only factory authorized replacement bag No. 764-0191.

111-638A



NOTE

This instruction manual covers various models and all specifications shown do not necessarily apply to your model. Specifications subject to change without notice or obligation.

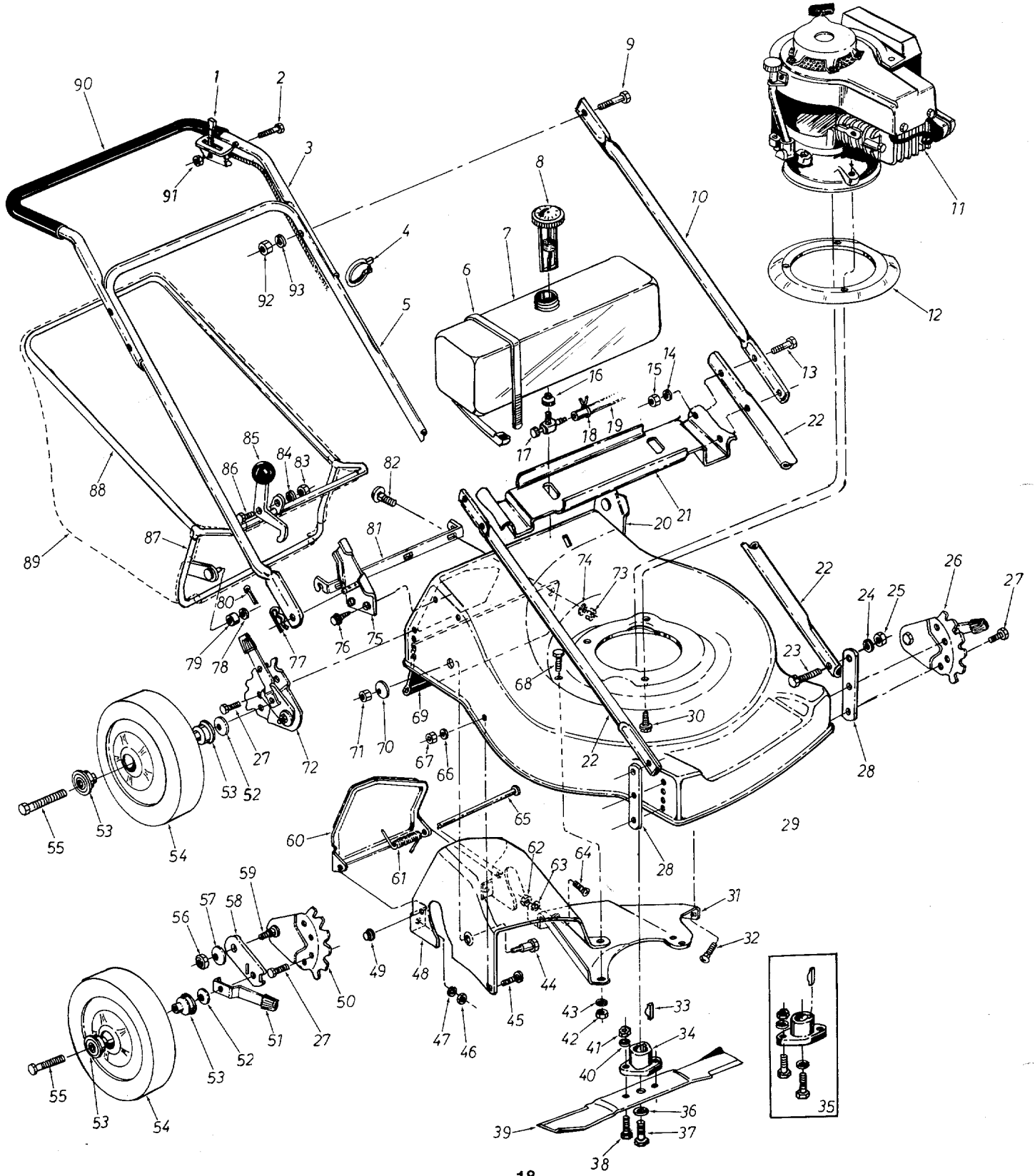

111-638A

PARTS LIST FOR MODEL 111-638A

REF.	PART NO.	COLOR CODE	DESCRIPTION	NEW PART	REF. NO.	PART NO.	COLOR CODE	DESCRIPTION	NEW PART
2	746-0425		Throttle Control Ass'y. Comp.	N	48	13406	—488	Rear Chute—R.H.	
3	710-0606		Hex Bolt 1/4-20 x 1.50" Lg.*		49	726-0106		Push Nut 1/4" Rod	
4	749-0378		Upper Handle		50	12323		Index Plate	
5	726-0188		Plastic Cable Tie		51	10531		Spring Lever Ass'y. w/Knob	
6	749-0374		Lower Handle		52	736-0105		Bell-Wash. 3/8" I.D.	
7	726-0153		Gas Tank Straps		53	741-0332		Flanged Ball Bearing	N
8	751-0225		Gas Tank		54	734-1062		Wheel Ass'y. Comp. 8 x 1.75	N
9	723-0155		Gas Gauge		55	710-0427		Hex Bolt 3/8-16 x 2.00" Lg.	
10	710-0380		Hex Bolt 5/16-18 x 1.75" Lg.*		56	712-0375		Hex Cent. L-Nut 3/8-16 Thd.	
11	749-0514		Upper Strut	N	57	736-0255		Bell-Wash. .50" I.D. x 1.14" O.D.	
	4 H.P.		Engine Tec. Model TVS 105 XL		58	10619		Pivot Bar	
12	13773		Engine Mount Cover Plate		59	738-0269		Shoulder Bolt (3/8-16 Thd.)	
13	710-0442		Hex Bolt 5/16-18 x 1.50" Lg.*		60	13407	—488	Chute Door	
14	736-0119		L-Wash. 5/16" I.D.*		61	732-0346		Torsion Spring	
15	712-0158		Hex Cent. L-Nut 5/16-18 Thd.		62	712-0271		Hex Sems Nut 1/4-20 Thd.*	
16	735-0149		Bushing (Gas Tank)		63	736-0329		L-Wash. 1/4" I.D.*	
17	751-0171		Fuel Shut-Off Valve		64	710-0167		Carriage Bolt 1/4-20 x .50" Lg.*	
18	726-0183		Hose Clamp 3/8" I.D.		65	738-0386		Hinge Pin .250" Dia. x 7.25" Lg.	
19	—		Gas Line (Comes w/Engine)					L-Wash. 1/4" I.D.*	
20	12297		Handle Mount Brkt. Ass'y.		66	736-0329		Hex Sems Nut 1/4-20 Thd.*	
21	14426		Gas Tank Mounting Brkt.	N	67	712-0271		Hex Bolt 1/4-20 x .62" Lg.*	
22	749-0513		Lower Strut	N	68	710-0258		Rear Flap Ass'y.	
23	710-0118		Hex Bolt 5/16-18 x .75" Lg.*		69	731-0449		Bell-Wash. .440" I.D.	
24	736-0119		L-Wash. 5/16" I.D.*		70	736-0219		Hex Jam Nut 3/8-16 Thd.	
25	712-0158		Hex Cent. L-Nut 5/16-18 Thd.		71	712-0342		Height Adjuster Ass'y.	
26	12321		Height Adjuster Ass'y. Comp.—L.H.		72	12322		Comp.—R.H.	
	710-0209		Hex Sems Bolt 3/8-16 x .62" Lg.*		73	712-0287		Hex Nut 1/4-20 Thd.*	
28	14425		Strut Mounting Bracket	N	74	736-0329		L-Wash. 1/4" I.D.*	
29	14004	—488	22" Deck Ass'y.		75	12296		Handle Mount Brkt. Ass'y.	
30	710-0654		Hex Wash. Hd. Self-Tap Scr. 3/8-16 x .88" Lg.		76	710-0776		Hex Wash. Hd. Self-Tap Scr. 1/4-20 x .62" Lg.	
31	14014	—488	Rear Chute Baffle—L.H.		77	714-0104		Hairpin Cotter 5/16" Dia.	
32	710-0167		Carriage Bolt 1/4-20 x .50" Lg.*		78	736-0185		Fl-Wash. .406" I.D. x .75" O.D.	
33	714-0365		#6 Hi-Pro Key 5/32 x 5/8" Dia.		79	731-0430		Plastic Roller	
34	10769		Blade Adapter Kit		80	714-0507		Cotter Pin 5/32" Dia. x .75" Lg.*	
35	10769		Blade Adapter Kit		81	14012	—488	Grass Catcher—Hitch Brkt.	
36	736-0217		L-Wash. 3/8" I.D.—H.D.		82	710-0703		Carriage Bolt 1/4-20 x .75" Lg.*	
37	710-0459		Hex Bolt 3/8-24 x 1.50" Lg. (Grade 5)		83	712-0267		Hex Nut 5/16-18 Thd.*	
38	710-0117		Hex Bolt 5/16-24 x 1.00" Lg. (Grade 5)		84	736-0119		L-Wash. 5/16" I.D.*	
39	742-0125		22" Blade		85	13435		Cam Lever—Grip Ass'y.	
40	736-0119		L-Wash. 5/16" I.D.*		86	738-0140		Shld. Bolt	
41	712-0123		Hex Nut 5/16-24 Thd.*		87	13924		Grass Catcher Lower Frame Ass'y.	
42	712-0287		Hex Nut 1/4-20 Thd.*		88	749-0512		Grass Catcher Upper Frame	N
43	736-0329		L-Wash. 1/4" I.D.*		89	764-0191		Grass Bag	N
44	738-0430		Shoulder Bolt .50" I.D. x .605" Lg.		90	718-0145		Grip	
45	710-0167		Carriage Bolt 1/4-20 x .50" Lg.*		91	712-0107		Hex Cent. L-Nut 1/4-20 Thd.	
46	712-0287		Hex Nut 1/4-20 Thd.*		92	712-0158		Hex Cent. L-Nut 5/16-18 Thd.	
47	736-0329		L-Wash. 1/4" I.D.*		93	736-0119		L-Wash. 5/16" I.D.*	

*For faster service obtain standard nuts, bolts and washers locally. If these items cannot be obtained locally, order by part number and size as shown on parts list.

(488—Mack Truck Yellow)

When ordering parts, if color or finish is important use the appropriate color code shown above. (e.g. Mack Truck Yellow Finish—14004 (488).)

NOTE: The engine is not under warranty by the mower manufacturer . . . If repairs or service is needed on the engine, please contact your nearest authorized engine service outlet. Check the "Yellow Pages" of your telephone book under "Engines—Gasoline."



PARTS INFORMATION

POWER EQUIPMENT PARTS AND SERVICE

Parts and service for all MTD manufactured power equipment are available through the authorized service firms listed below. All orders should specify the model number of your unit, part numbers, description of parts and the quantity of each part required.

NOTE: If any parts are found to be missing or defective upon assembly of this unit, write to advise the factory so that immediate replacement can be made.

ALABAMA	BIRMINGHAM
Auto Electric & Carburetor Co.	2625 4th Ave. S. 35233
ARKANSAS	FORT SMITH
Mity Mite Motors, Inc.	4515 S. 16th St. 72901
	NORTH LITTLE ROCK
Sutton's Lawn Mower Shop	Rt. 4, Box 368 72117
CALIFORNIA	PORTERVILLE
Billious	75 North D Street 93257
	SAN FRANCISCO
J.W. Jewett Co.	981 Folsom St. 94107
COLORADO	DENVER
Spitzer Industrial Products Co.	Box 59, 43 W. 9th Ave. 80201
FLORIDA	JACKSONVILLE
Radco Distributors	4909 Victor St. 32207
	OPA LOCKA
Small Eng. Dist.	2351 N.W. 147th St. 33054
GEORGIA	EAST POINT
East Point Cycle & Key	2834 Church St. 30344
ILLINOIS	LYONS
Keen Edge Co.	8615 Ogden Ave. 60534
INDIANA	ELKHART
Parts & Sales Inc.	2101 Industrial Pkwy. 46514
IOWA	DUBUQUE
Power Lawn & Garden Equip.	2551 J.F. Kennedy 52001
LOUISIANA	NEW ORLEANS
Suhren Engine Co.	8330 Earhart Blvd. 70118
MARYLAND	TAKOMA PARK
Center Supply Co.	6867 New Hampshire Ave. 20012
MASSACHUSETTS	SPRINGFIELD
Morton B. Collins Co.	300 Birnie Ave. 01107
MICHIGAN	LANSING
Lorenz Service Co.	2500 S. Pennsylvania 48910
	MOUNT CLEMENS
Power Equipment Dist.	36463 South Gratiot 48043
MINNESOTA	HOPKINS
Hance Distributing Inc.	420 Excelsior Ave. W. 55343
MISSISSIPPI	BILOXI
Biloxi Sales & Service, Inc.	506 Caillavet St. 39533
MISSOURI	KANSAS CITY
Automotive Equip. Service	3117 Holmes St. 64109
	ST. JOSEPH
Ross-Frazier Supply Co.	8th and Monterey 64503
	ST. LOUIS
Henzler, Inc.	2015 Lemay Ferry Road 63125
NEW JERSEY	BELLMAWR
Lawnmower Parts Inc.	717 Creek Rd. 08030
NEW YORK	CARTHAGE
Gamble Dist., Inc.	West End Ave. 13619

BRIGGS AND STRATTON, TECUMSEH AND PEERLESS PARTS AND SERVICE

Briggs & Stratton, Tecumseh and Peerless parts and service should be handled by your nearest authorized engine service Check the yellow pages of your telephone directory under the listing **Engines—Gasoline**, Briggs & Stratton or Tecumseh Lauson.

NORTH CAROLINA	GOLDSBORO
Smith Hardware Co.	515 N. George St. 27530
	GREENSBORO
Dixie Sales Company	335 N. Green 27402
OHIO	CARROLL
Stebe's Mid-State Mower Supply	Box 366, 71 High St. 43112
	CLEVELAND
Bleckrie, Inc.	7900 Lorain Ave. 44102
	WADSWORTH
National Central	687 Seville Rd. 44281
	YOUNGSTOWN
Burton Supply Co.	1301 Logan Ave. Box 929 44501
OKLAHOMA	MUSKOGEE
Victory Motors, Inc.	605 S. Cherokee 74401
	OKLAHOMA CITY
Forest Sales Inc.	6415 N. Olie 73116
OREGON	PORTLAND
Kenton Supply Co.	8216 N. Denver Ave. 97217
PENNSYLVANIA	CHESTER
Stull Equipment Corp.	742 W. Front St. 19013
	HARRISBURG
EECO Inc.	4021 N. 6th St. 17110
	PHILADELPHIA
Thompson Rubber Co.	5222-24 N. Fifth St. 19120
	PITTSBURGH
Bluemont Co.	11125 Frankstown Rd. 15235
	PUNXSUTAWNEY
Frank Roberts & Sons	R.D. 2
TENNESSEE	KNOXVILLE
Master Repair Service	2000 Western Ave. 37921
	MEMPHIS
American Sales & Service, Inc.	3035-43 Bellbrook 38116
TEXAS	DALLAS
Marr Brothers, Inc.	423 E. Jefferson 75203
	FORT WORTH
Woodson Sales Corp.	1702 N. Sylvania 76111
	HOUSTON
Bullard Supply Co.	2409 Commerce St. 77003
	SAN ANTONIO
Catto & Putty, Inc.	414 Live Oak 78298
UTAH	SALT LAKE CITY
A-1 Engine & Mower Co.	437 E. 9th St. 84111
VERMONT	BURLINGTON
Vermont Hdwe. Co. Inc.	180 Flynn Ave. 05401
VIRGINIA	ASHLAND
RBI Corp.	Lake Ridge Park 101 Cedar Run Dr. 23005
	SEATTLE
WASHINGTON	Bailey's Inc. 1414 14th Ave. 98102
WEST VIRGINIA	CHARLESTON
Young's, Inc.	233 Virginia St., E. 25301
WISCONSIN	MARSHFIELD
Power Pac	301 E. 29th St. 54449

WARRANTY PARTS AND SERVICE POLICY

The purpose of warranty is to protect the customer from defects in workmanship and materials, defects which are NOT detected at the time of manufacture. It does not provide for the unlimited and unrestricted replacement of parts. Use and maintenance are the responsibility of the customer. The manufacturer cannot assume responsibility for conditions over which it has no control. Simply put, if it's the manufacturer's fault, it's the manufacturer's responsibility; if it's the customer's fault, it's the customer's responsibility.

CLAIMS AGAINST THE MANUFACTURER'S WARRANTY INCLUDES:

1. Replacement of Missing Parts on new equipment.
2. Replacement of Defective Parts within the warranty period.
3. Repair of Defects within the warranty period.

All claims MUST be substantiated with the following information:

1. Model Number of unit involved.
2. Date unit was purchased or first put into service.
3. Date of failure.
4. Nature of failure.